

The Coleby Insert Assembly Guide

Contents

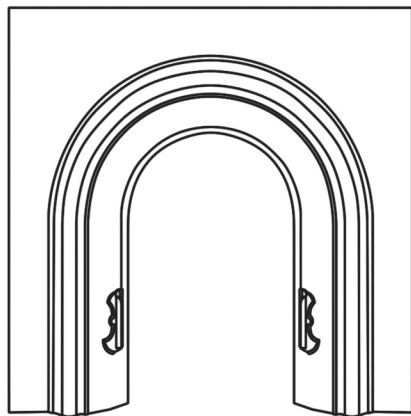

Fireplace Fascia



Damper Plate

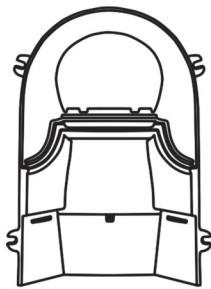

Fireplace Back



Cast Iron Firebrick Retaining Plate

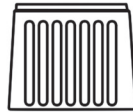

Fire Brick



Bars



Grate

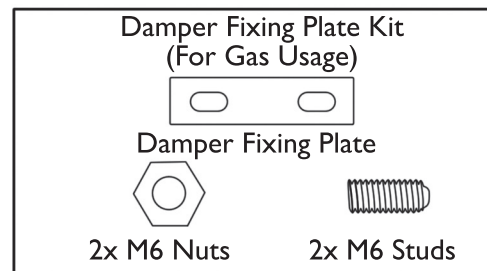

Damper Fixing Plate Kit (For Gas Usage)

Damper Fixing Plate

2x M6 Nuts

2x M6 Studs

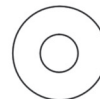

5x M6 Washers



5x M6 Bolts



4x M6 Studs



Ashpan Cover

Please note, a 10mm spanner is required to assemble this fireplace.

1 GAS USAGE ONLY

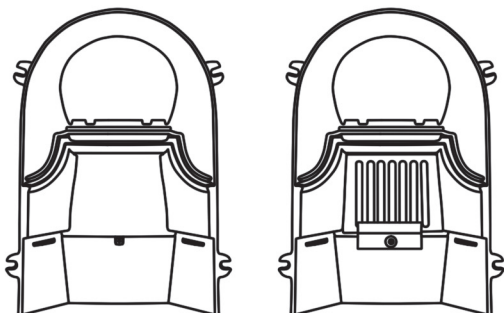

Position Firebrick in place and hold in using the Cast Iron Firebrick Retaining Plate, securing with 1 x M6 Stud, Washer and Bolt.

THIS STEP IS NOT REQUIRED FOR SOLID FUEL USE

2 SOLID FUEL USAGE ONLY



Lay Fireplace Back down on level ground. Position Firebrick in place and then insert 1 x M6 Stud into the hole just below the Firebrick. Insert Grate into the groves on the Fireplace Back, passing the fixing lug over the M6 Stud. Secure in place with 1 x M6 Washer and 1 x M6 Bolt.

THIS STEP IS NOT REQUIRED FOR GAS USAGE.

3

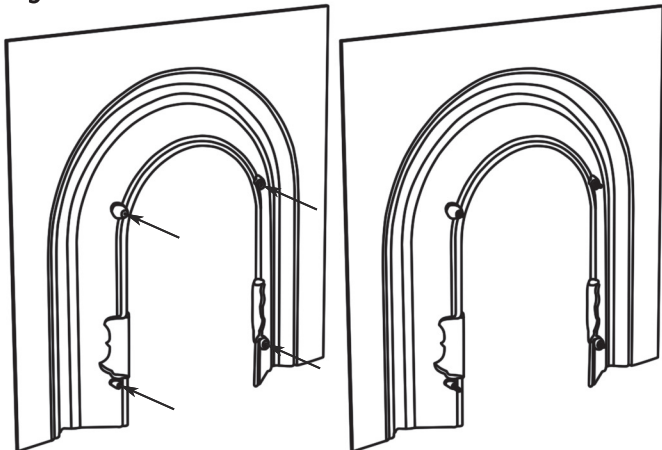

Insert the 4 x M6 Studs into the back of the Fireplace Fascia.

4

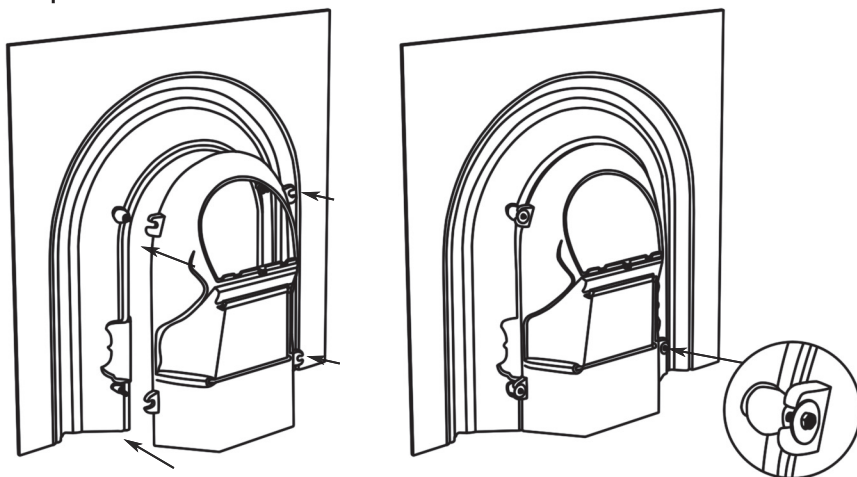

Attach Fireplace Back to the back of the Fireplace Fascia, ensuring that the M6 Studs pass through the fixing brackets on the Fireplace Back. Secure and tighten using 4 x M6 Washers and 4 x M6 Nuts.

Carron

www.carronheating.co.uk

T: 01400 263 319 | E: sales@carronheating.co.uk

The Coleby Insert Assembly Guide

5

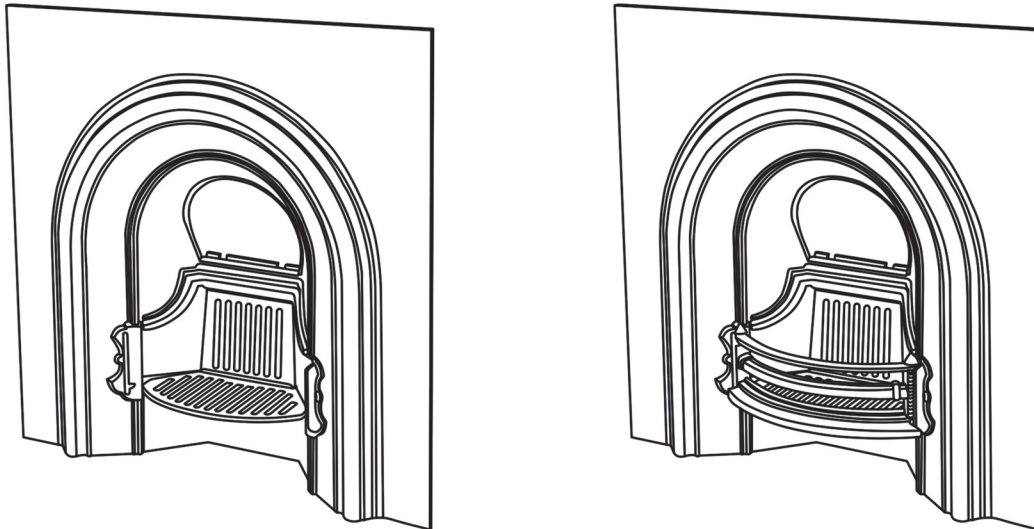

Slot the Bars into the groves on the front of the Fireplace Fascia. No Grate Required for Gas Usage.

6

SOLID FUEL USAGE

GAS USAGE

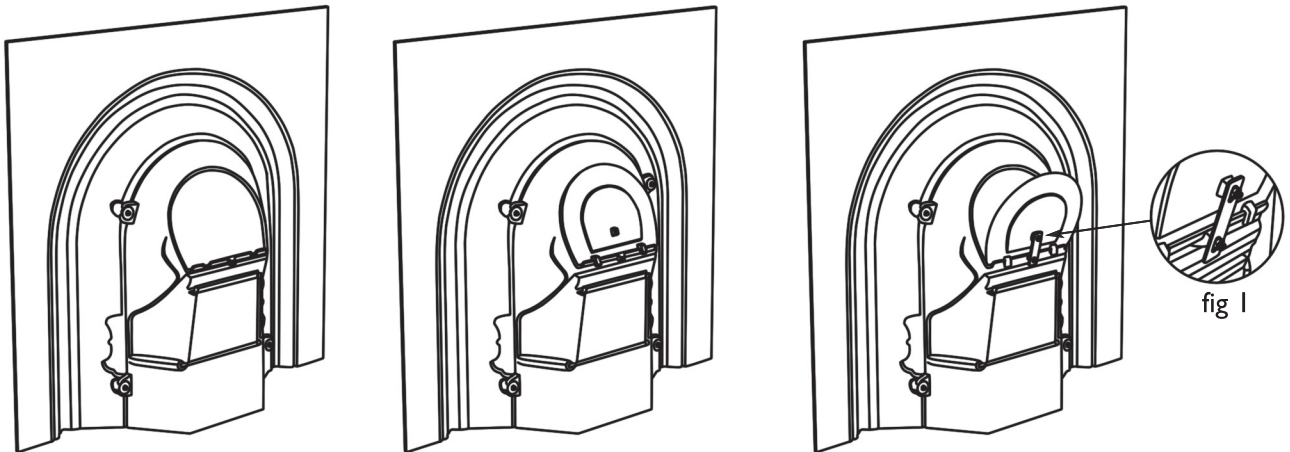

Solid Fuel Usage: Rest the Damper Plate onto the groove on the back of the Fireplace Back.

Gas Usage: The Damper Plate must remain fixed open for Gas Usage by using the Damper Plate fixing Kit. Insert M6 Studs into the holes on the back of the Damper Plate and Fireplace Back, pass Damper Fixing Plate over these and secure with M6 Bolts (see fig 1).

7

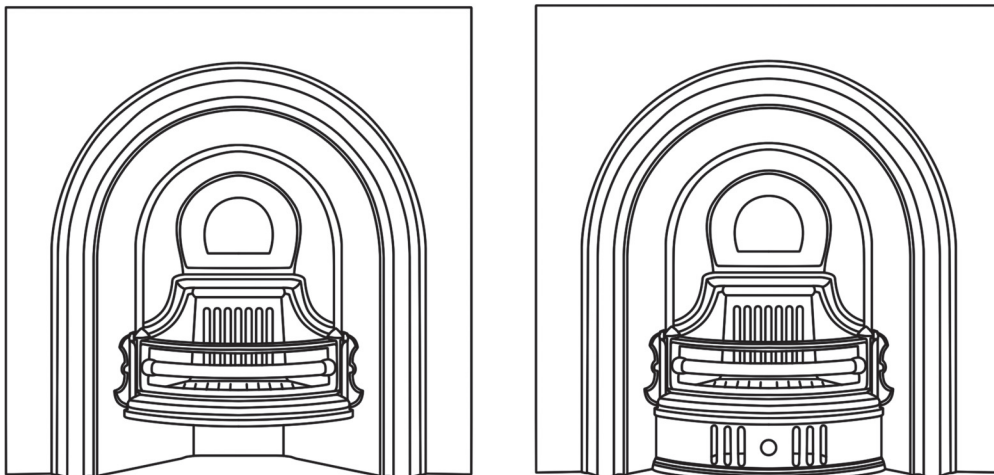

To complete, place Ashpan Cover below Grate and Bars on the front of the Fireplace.

Carron

www.carronheating.co.uk

T: 01400 263 319 | E: sales@carronheating.co.uk